

## DHY-04V VoLTE 4G Hybrid

Single Automatic 4G Hybrid with HD Voice, AES/EBU & Analogue I/O with Ethernet



# SONIFEX

Audio Solutions for  
AV & Broadcast Media

For the latest Sonifex handbook information please visit the  
Sonifex website at [www.sonifex.co.uk](http://www.sonifex.co.uk)

This handbook is for use with the following product:

DHY-04V - Single Automatic 4G Hybrid with HD Voice, AES/EBU & Analogue I/O With Ethernet

©Sonifex Ltd, 2025

All Rights Reserved

Revision 1.00, January 2025

Sonifex Ltd, 61, Station Road, Irthlingborough,

Northants, NN9 5QE, England.

Tel: +44 (0)1933 650 700

Email: [sales@sonifex.co.uk](mailto:sales@sonifex.co.uk)

Website: <https://www.sonifex.co.uk>

Information in this document is subject to change without notice and does not represent a commitment on the part of the vendor. Sonifex Ltd shall not be liable for any loss or damage whatsoever arising from the use of information or any error contained in this manual.

No part of this manual may be reproduced or transmitted in any form or by any means, electronic or mechanical, including photocopying, recording, information storage and retrieval systems, for any purpose other than the purchaser's personal use, without the express written permission of Sonifex Ltd. Unless otherwise noted, all names of companies, products and persons contained herein are part of a completely fictitious adaptation and are designed solely to document the use of Sonifex product.

# Contents

## Product Warranty - 2 Year Extended

### Sonifex Warranty & Liability Terms & Conditions

1. Definitions
2. Warranty

### Unpacking Your Product

### Repairs & Returns

## Safety of Installation of Mains Operated Equipment CE and UKCA Conformity

### WEEE Directive

## 1 What Is A Telephone Hybrid?

### DHY-04V Single Automatic GSM Hybrid, AES/EBU & Analogue I/O With Ethernet

- DHY-04V Single Freestanding Automatic VoLTE 4G Hybrid
- DHY-04VS Single Rackmount Automatic VoLTE 4G Hybrid
- DHY-04VT Twin Rackmount Automatic VoLTE 4G Hybrid

## 2 Configuration & Controls - DHY-04V

### Front Panel Controls

- Power LED Indicator
- Reset Button
- Speed Dial Buttons
- AES/EBU Lock LED
- Line Hold/Connect Button
- Gain Switches (Level To & From The Line)
- LED Bargraphs & Signal Strength Indicator
- Network LED
- SIM Enabled LED
- Signal Strength Button
- Status & Operating Mode Information

### DHY-04V Internal Controls & Adjustments

- Jumper and Select Switcher Functions

### Rear Panel Controls & Connections

- AES/EBU & Analogue Combined Line Output
- Mic/Line & AES/EBU Input
- Mic/Line Input Select Switch
- Adjusting the Microphone Gain Level
- Remotes
- Conference Audio/Record Output

i  
i  
i  
iii  
iii  
iv  
iv  
1

1  
2  
3  
3  
4  
4  
4  
4  
4  
4  
4  
5  
5  
5  
5  
5  
5  
5  
5  
6  
6  
6  
6  
6  
6  
6  
6  
6  
6

GSM Antenna	7
SIM Card Slot	7
RS232 Serial Port	7
Ethernet Port	7
Mains Input	8
Protective Earth Terminal	8
Configuration Settings DIPswitches	8
<b>3 Connecting the DHY-04V</b>	<b>9</b>
IEC Mains	9
GSM Antenna	9
Remote Line Hold	9
Mic/Line Input	9
XLR Output	9
Using The AES/EBU Input & Output	10
Using The Webserver To Configure Options	10
<b>Using the DHY-04V</b>	<b>10</b>
Call Established	11
Using the Conference Port as a Record Output	11
Using the Conference Port to Share a Stereo Digital Audio Connection between Two DHY-04V Units	11
<b>4 Hybrid Technical Description</b>	<b>12</b>
Echo Cancellation	12
<b>5 Serial Port Control</b>	<b>13</b>
<b>DHY-04V Serial Connection</b>	<b>13</b>
SCI Software	13
<b>Serial Interface Commands &amp; Responses</b>	<b>13</b>
Error Messages	13
<b>6 Webserver &amp; Network Discovery</b>	<b>14</b>
Connecting to the Device	14
First Time Usage	14
MDNS-SD and Bonjour	14
Sonifex Service Discovery App	14
<b>Home Page</b>	<b>16</b>
Status	16
Line	16
Dial	16
<b>Dialler Page</b>	<b>17</b>
Call State	17
Dial	17
<b>Configuration</b>	<b>18</b>

Config Name	18
Description	18
Echo Duration	18
Local Number	18
Conference Port Function	18
Force Analogue Output	19
Answer Control	19
Submit Button	19
Remote Input Port	19
Remote Output Port	19
DTMF during the call	20
Auto Redial	20
<b>Password Setting</b>	<b>21</b>
<b>Network Settings</b>	<b>22</b>
Bonjour Name	22
Static IP Address	22
Static Subnet Mask	23
Gateway IP Address	23
Dynamic Addressing	23
<b>Device Info Page</b>	<b>24</b>
<b>Update Firmware Page</b>	<b>25</b>
Update Firmware	25
Update GSM Module	26
Update Config Files	26
Clear Settings	26
<b>Log In</b>	<b>27</b>
<b>Bootstrap Mode</b>	<b>28</b>
<b>7 Technical Specification DHY-04V</b>	<b>29</b>



DHY-04V  
VoLTE Hybrid

Speed Dial



Redial

AES Lock

Line Hold

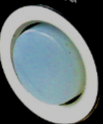

Level From Line



Level To Line

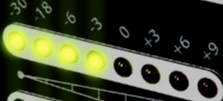

dB



dB

Signal Strength



SIM Enabled



SONIFEX

SONIFEX

# SONIFEX

## Register Online for an Extended 2 Year Warranty

As standard, Sonifex products are supplied with a 1 year back to base warranty.

If you register the product online, you can increase your product warranty to 2 years and we can also keep you informed of any product design improvements or modifications.

Product: \_\_\_\_\_

Serial No: \_\_\_\_\_

To register your product, please go online to [www.sonifex.co.uk/register](http://www.sonifex.co.uk/register)

## Product Warranty - 2 Year Extended

As standard, Sonifex products are supplied with a 1 year back to base warranty. In order to register the date of purchase and so that we can keep you informed of any product design improvements or modifications, it is important to complete the warranty registration online. Additionally, if you register the product on the Sonifex website, you can increase your product warranty to 2 years. Go to the Sonifex website at: [www.sonifex.co.uk/register](http://www.sonifex.co.uk/register) to apply for your 2 year warranty.

## Sonifex Warranty & Liability Terms & Conditions

### 1. Definitions

‘the Company’ means Sonifex Ltd and where relevant includes companies within the same group of companies as Sonifex Limited.

‘the Goods’ means the goods or any part thereof supplied by the Company and where relevant includes: work carried out by the Company on items supplied by the Purchaser; services supplied by the Company; and software supplied by the Company.

‘the Purchaser’ means the person or organisation who buys or has agreed to buy the Goods.

‘the Price’ means the Price of the Goods and any other charges incurred by the Company in the supply of the Goods.

‘the Warranty Term’ is the length of the product warranty which is usually 12 months from the date of despatch; except when the product has been registered at the Sonifex website when the Warranty Term is 24 months from the date of despatch.

‘the Contract’ means the quotation, these Conditions of Sale and any other document incorporated in a contract between the Company and the Purchaser.

This is the entire Contract between the parties relating to the subject matter hereof and may not be changed or terminated except in writing in accordance with the provisions of this Contract. A reference to the consent, acknowledgement, authority or agreement of the Company means in writing and only by a director of the Company.

### 2. Warranty

- a. The Company agrees to repair or (at its discretion) replace Goods which are found to be defective (fair wear and tear excepted) and which are returned to the Company within the Warranty Term provided that each of the following are satisfied:
  - i. notification of any defect is given to the Company immediately upon its becoming apparent to the Purchaser;
  - ii. the Goods have only been operated under normal operating conditions and have only been subject to normal use (and in particular the Goods must have been correctly connected and must not have been subject to high voltage or to ionising radiation and must not have been used contrary to the Company’s technical recommendations);
  - iii. the Goods are returned to the Company’s premises at the Purchaser’s expense;
  - iv. any Goods or parts of Goods replaced shall become the property of the Company;
  - v. no work whatsoever (other than normal and proper maintenance) has been carried out to the Goods or any part of the Goods without the Company’s prior written consent;
  - vi. the defect has not arisen from a design made, furnished or specified by the Purchaser;
  - vii. the Goods have been assembled or incorporated into other goods only in accordance with any instructions issued by the Company;

- viii. the defect has not arisen from a design modified by the Purchaser;
  - ix. the defect has not arisen from an item manufactured by a person other than the Company. In respect of any item manufactured by a person other than the Company, the Purchaser shall only be entitled to the benefit of any warranty or guarantee provided by such manufacturer to the Company.
  - b. In respect of computer software supplied by the Company the Company does not warrant that the use of the software will be uninterrupted or error free.
  - c. The Company accepts liability:
    - (i) for death or personal injury to the extent that it results from the negligence of the Company, its employees (whilst in the course of their employment) or its agents (in the course of the agency);
    - (ii) for any breach by the Company of any statutory undertaking as to title, quiet possession and freedom from encumbrance.
- Subject to conditions (a) and (c) from the time of despatch of the Goods from the Company's premises the Purchaser shall be responsible for any defect in the Goods or loss, damage, nuisance or interference whatsoever consequential economic or otherwise or wastage of material resulting from or caused by or to the Goods. In particular the Company shall not be liable for any loss of profits or other economic losses. The Company accordingly excludes all liability for the same.
- a. At the request and expense of the Purchaser the Company will test the Goods to ascertain performance levels and provide a report of the results of that test. The report will be accurate at the time of the test, to the best of the belief and knowledge of the Company, and the Company accepts no liability in respect of its accuracy beyond that set out in Condition (a).
  - f. Subject to Condition (e) no representation, condition, warranty or other term, express or implied (by statute or otherwise) is given by the Company that the Goods are of any particular quality or standard or will enable the Purchaser to attain any particular performance or result, or will be suitable for any particular purpose or use under specific conditions or will provide any particular capacity, notwithstanding that the requirement for such performance, result or capacity or that such particular purpose or conditions may have been known (or ought to have been known) to the Company, its employees or agents.
  - g.
    - (i) To the extent that the Company is held legally liable to the Purchaser for any single breach of contract, tort, representation or other act or default, the Company's liability for the same shall not exceed the price of the Goods.
    - (ii) The restriction of liability in Condition (g)(i) shall not apply to any liability accepted by the Seller in Condition (c).
  - h. Where the Goods are sold under a consumer transaction (as defined by the Consumer Transactions (Restrictions on Statements) Order 1976) the statutory rights of the Purchaser are not affected by these Conditions of Sale.



## Unpacking Your Product

Each product is shipped in protective packaging and should be inspected for damage before use. If there is any transit damage take pictures of the product packaging and notify the carrier immediately with all the relevant details of the shipment. Packing materials should be kept for inspection and also for if the product needs to be returned.

The product is shipped with the following equipment so please check to ensure that you have all of the items below. If anything is missing, please contact the supplier of your equipment immediately.

Item	Quantity
Product unit	1

## Atmosphere/Environment

This apparatus should be installed in an area that is not subject to excessive temperature variation (<0°C, >50°C), moisture, dust or vibration.

This apparatus shall not be exposed to dripping or splashing, and no objects filled with water, such as vases shall be placed on the apparatus.

## Repairs & Returns

Please contact Sonifex or your supplier if you have any problems with your Sonifex product. Email [technical.support@sonifex.co.uk](mailto:technical.support@sonifex.co.uk) for the repair/upgrade/returns procedure, or for support & questions regarding the product operation.

## Safety & Installation of Mains Operated Equipment

There are no user serviceable parts inside the equipment. If you should ever need to look inside the unit, always disconnect the mains supply before removing the equipment covers. The cover is connected to earth by means of the fixing screws. It is essential to maintain this earth/ground connection to ensure a safe operating environment and provide electromagnetic shielding.

## Voltage Setting Checks

Ensure that the machine operating voltage is correct for your mains power supply by checking the box in which your product was supplied. The voltage is shown on the box label. The available voltage settings are 115V, or 230V. Please note that all products are either switchable between 115V and 230V, or have a universal power supply.

## Fuse Rating





The product is supplied with a single fuse in the live conducting path of the mains power input. For reasons of safety it is important that the correct rating and type of fuse is used. Incorrectly rated fuses could present a possible fire hazard, under equipment fault conditions. The active fuse is fitted on the outside rear panel of the unit.

## Power Cable & Connection

An IEC power connector is supplied with the product which has a moulded plug attached.

The mains plug or IEC power connector is used as the disconnect device. The mains plug and IEC power connector shall remain readily operable to disconnect the apparatus in case of a fault or emergency.

The mains lead is automatically configured for the country that the product is being sent to, from one of:

Territory	Voltage	IEC Lead Type	Image
UK & Middle East	230V	UK 3 pin to IEC lead	
Europe	230V	European Schuko round 2 pin to IEC lead	
USA, Canada and South America	115V	3 flat pin to IEC lead	
Australia & New Zealand	230V	Australasian 3 flat pin to IEC lead	

Connect the equipment in accordance with the connection details and before applying power to the unit, check that the machine has the correct operating voltage for your mains power supply.

This apparatus is of a class I construction. It must be connected to a mains socket outlet with a protective earthing connection.

**Important note:** If there is an earth/ground terminal on the rear panel of the product then it must be connected to Earth.

## CE and UKCA conformity

The products in this manual comply with the essential requirements of the relevant UK and European health, safety and environmental protection legislation. The technical justification file for this product is held at Sonifex Ltd. Relevant declarations of conformity can be found at: <https://www.sonifex.co.uk/declarations>

## WEEE Directive



Directive 2012/19/EU of the European Parliament and of the Council of 4th July 2012 lays down measures to protect the environment and human health by preventing or reducing the adverse impacts of the generation and management of waste from electrical and electronic equipment (WEEE).

The policy of Sonifex Ltd is to comply with all applicable laws of all jurisdictions having authority over Sonifex's business, including the WEEE directive. Accordingly, Sonifex has implemented a rigorous program designed to ensure compliance of its products with the WEEE directive. The latest statements can be found at: <https://www.sonifex.co.uk/company/recycling>

## 1 What Is A Telephone Hybrid?

Telephone hybrids, or telephone balance units (TBUs) provide the interface between professional audio equipment and the telephone networks. They provide protection for your equipment and the telephone lines, allowing for varying line signals and line conditions. Automatically cancelling out the unwanted signal they also facilitate two-way communication down a single telephone line.

A typical telephone hybrid has a telephone line connection, a handset connection and separate terminals for audio input and output from a broadcast mixer, or other professional audio source. This GSM unit has no telephone line or handset connection, using an internal GSM receiver/transmitter to receive and make calls.

A large proportion of Sonifex hybrids are used in radio and television broadcasting applications for allowing external callers to be connected to the studio mixing console. Most of the other units are supplied to communication operations for allowing extremely effective conversion between 4-wire audio circuits and standard telephone lines.

### DHY-04V Single Automatic GSM Hybrid, AES/EBU & Analogue I/O With Ethernet

The DHY-04V VoLTE Hybrid is used on a cellular (mobile) phone network, and provides HD Voice quality calling over 4G, as legacy 3G and 2G mobile services in many countries are now being switched off. The DHY-04V can accept a SIM card in the rear panel slot and by connecting a suitable GSM antenna, it can receive and make high quality broadcast calls over the cellular network, converting the 4G call to the 4 wire audio signal to and from a connected mixing console. The module used in the DHY-04V can take and make calls on any 4G GSM network, and can fallback to 3G and 2G if required.

It is ideal for studios in remote locations, for OB vans and trucks on the move, and in emergency situations where a telephone landline can't be guaranteed, the DHY-04V offers outstanding performance.

The DHY-04V has all features of the DHY-04 together with some additional front panel indicators. There are two LEDs, one for SIM enabled and one for GSM Network availability. Additionally there is a push button which allows the mobile signal level to be displayed on the meter LEDs.

#### **Product Function:**

Provides separation between send and receive signals on a 4G GSM network, provides professional level balanced input & output signals and has echo cancellation.

# 1 What Is A Telephone Hybrid?

## HD Voice:

The signal quality can vary during the call. Normally the hybrid will be used in a fixed location (even OB trucks are normally stationary), so the position of the antenna can be refined for best signal quality. However the far end may be from a cellular phone, so may vary in quality and which can lead to dynamic bandwidth changes during a call. It is mostly true that network providers will only handle HD Voice on 4G and 3G networks though, in theory, it should also be compatible with enhanced 2G networks.

## Typical Applications:

Radio & TV station outside broadcast vehicles for talk shows, telephony interface to the mixer. Backup hybrid to cover failure of main landline.

## Features:

- Multi band support for 4G, 3G and 2G.
- Rear panel 4G, 3G or 2G GSM SIM card insertion.
- Ethernet web server control and configuration.
- Front panel speed-dial buttons with redial.
- Signal strength LED display.
- LEDs for SIM enabled and GSM network availability.
- Automatic operation.
- Combined AES/EBU and analogue input and output.



### DHY-04VS Single Rackmount Automatic VoLTE 4G Hybrid



### DHY-04VT Twin Rackmount Automatic VoLTE 4G Hybrid



## 2 Configuration & Controls - DHY-04V

### Front Panel Controls

#### Power LED Indicator

The power LED indicates that the equipment is powered and operational when illuminated.

#### Reset Button

In the unlikely event that the DHY-04V unit fails to respond, press the reset button to reboot the unit.

The reset button can also be used to reset the configuration to the factory default. This can be especially useful if the network settings have been incorrectly entered. To do this, press the reset three times in succession as follows – press reset; wait for 7 seconds; press reset again; wait for 7 seconds; press reset again and the unit will clear all the current settings and return to the factory defaults.

#### Speed Dial Buttons

Press the appropriate button to call Speed Dial settings 1-4. Press and hold buttons 1-3 to call Speed Dial numbers 5-7 or press and hold Speed Dial 4 to redial the last number. The numbers are configured using the embedded webserver.

#### AES/EBU Lock LED

This is a red/green LED with green indicating a successful lock to the incoming AES/EBU signal, i.e. a valid AES signal is present. The LED is red for a non-valid AES/EBU input.

#### Line Hold/Connect Button

This is the front panel button used to connect calls to, and disconnect calls from, the GSM Network. The line connect button flashes when an incoming call is detected and illuminates to indicate the call has been connected.

Operation of this button can be remotely controlled by GPI.





### Gain Switches (Level To & From The Line)

These switches allow gain/attenuation to be applied to the incoming & outgoing analogue audio. Each switch has 3 positions. Rotating the switches clockwise give gains of -6dB, 0dB & +6dB. The normal position for both the transmit gain to the telephone line (lower switch) and for the receive gain from telephone line (upper switch) is 0dB.

### LED Bargraphs & Signal Strength Indicator

These 8 position bargraphs, by default, indicate the signal levels of the incoming XLR audio signal from the mixer (lower) and outgoing XLR audio to the mixer (upper). For best operation set the signal gain switches to achieve all 3 yellow LEDs mostly illuminated with occasional audio peaks lighting the first red LED.

The scale indicates from left to right: Green (-30dB, -18dB, -6dB); Yellow (-3dB, 0dB, +3dB); & Red (+6dB, +9dB). They also show the GSM signal strength when the Signal Strength Button is pressed.

### Network LED

This blue LED indicates that the unit has established a connection with a GSM base station.

### SIM Enabled LED

This green LED indicates that the unit has a valid SIM card installed and that it has been registered with the GSM network.

### Signal Strength Button

Press and hold this button to use the bargraph display to indicate the GSM signal strength from 0-100%.

### Status & Operating Mode Information

The LED display is also used to indicate special operating modes and other settings as follows:

Alternating 2 LEDs on, 2 LEDs off pattern indicates that the DHY-04V is checking the status of the Line Connect Button to test the Bootstrap Mode (see Bootstrap mode on page 28).

Alternating 4 LEDs on, 4 LEDs off pattern indicates that the DHY-04V has entered Bootstrap mode, because either the Line Hold/Connect Button was held down for approximately 8 seconds at power up, or the main code has been corrupted (most likely due to a previous incomplete firmware update).

Alternating 8 LEDs on, 8 LEDs off pattern indicates that the DHY-04V has received an update command from the web page and is updating the firmware (valid in either Bootstrap or Normal operation).

### DHY-04V Internal Controls & Adjustments

If you need to get inside the unit to make configuration adjustments, simply remove the 4 screws in the corners of the rear panel. The rear panel and main PCB will slide backwards out of the metal chassis.

When re-inserting the main PCB, ensure that the PCB edges are in the runners inside the chassis and also that the power LED and line connect button are in the correct place in the front panel.

**Warning:** The power must be switched off at the supply or the power lead must be disconnected before attempting to open the unit. Removal of the cover can expose dangerous voltages.

### Jumper and Select Switcher Functions

Put a 2 pin jumper over J1 to switch in an extra 10dB of audio input gain to allow for use of domestic level mixing desks.

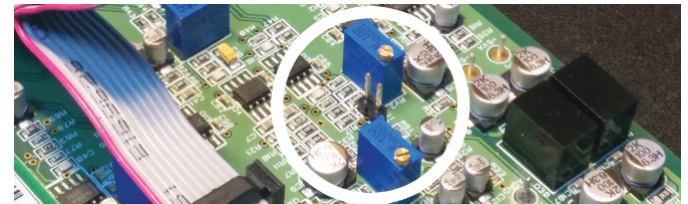

## Rear Panel Controls & Connections

### AES/EBU & Analogue Combined Line Output

The line output is an XLR 3 pin male connector with the following connections (XLR-3-32, 50Ω balanced floating). It outputs either balanced analogue or AES/EBU audio by following the input, i.e. a digital input produces a digital output.

- Pin 1: Screen
- Pin 2: Phase
- Pin 3: Non-Phase

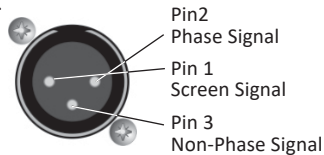

### Mic/Line & AES/EBU Input

The line input is an XLR 3 pin female connector (XLR-3-31, 10kΩ balanced floating). It is autosensing for either analogue balanced or AES/EBU (left channel) signals.

- Pin 1: Screen
- Pin 2: Phase
- Pin 3: Non-Phase

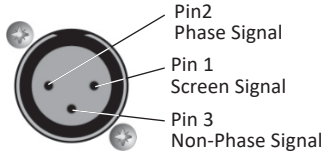

### Mic/Line Input Select Switch

This push-button switch sets the input signal mode:

- Switch depressed (in) - Mic input mode selected
- Switch not depressed (out) - Line input mode selected

### Adjusting the Microphone Gain Level

The Mic Level preset potentiometer controls the level of the input signal when the Mic/Line Input Select Switch is set to Mic input. The input signal level in Line mode is factory set and is not affected by this control. The Mic Input will accept 200Ω microphone level signals and is balanced/floating with a maximum gain of 70dB. Use a jeweller's screwdriver to adjust the gain between 65dB and 35dB. The gain range can be extended by  $\pm 6$ dB by using the front panel 'Level to The Line' switch.

### Remotes

The remote port allows you to control the line hold circuit from a mixing desk or other remote device and also outputs opto-isolated outputs to indicate the line hold status and the DTMF detect function.

The remote connector is a 9-way female (socket) 'D' type. To remotely control the line connect, connect pin 1 to pin 2. The action of this remote can act as momentary or latching by pin 6 having no connection or connecting to 0V respectively.

Pins 3 & 7 are an opto-isolated remote line connect indicator and pins 5 & 7 are an opto-isolated DTMF detect output. They can use the local supply pins 4 & 8 to drive an LED indicator or a low current load.

- Pin 1: Remote Line Connect Switch
- Pin 2: Common – 0V
- Pin 3: Opto-Isolated Line Connect Indicator - NPN Emitter
- Pin 4: Common – 0V
- Pin 5: Opto-Isolated User GPO (DTMF Detect\*) Indicator - NPN Emitter
- Pin 6: User GPI (Momentary/Latch Line Connect Switch - connect to 0V for latching action\*)
- Pin 7: Opto-Isolated Line Connect Indicator - NPN Collector
- Pin 8: 5V out (current limited supply for pins 7 & 9)
- Pin 9: Opto-Isolated User GPO Indicator - NPN Collector

The remote line connect indicator mimics the front panel Line Hold/Connect Switch lamp, i.e. it flashes when ringing and is on when the line is held.

\*These GPO and GPI default functions are set to the same as the fixed GPIO functions of the DHY-03.

### Conference Audio/Record Output

This is an RJ45 analogue audio connector to cross connect to another DHY-04V. This will allow a single TBU channel on a mixing desk to handle 2 calls, one to each DHY-04V. Alternatively the conference output signals can be



used as a record output by using the webserver interface. The output is then a sum of the caller and main audio input so both sides of the conversation can be recorded from this output.

- Pin 1: N/C
- Pin 2: N/C
- Pin 3: Conference Input (phase)
- Pin 4: Conference or Record Output (phase)
- Pin 5: Conference or Record Output (non-phase)
- Pin 6: Conference Input (non-phase)
- Pin 7: N/C
- Pin 8: N/C

### GSM Antenna

This is an SMA bulkhead connection to connect to an antenna to communicate with the GSM base station. We provide a simple ‘stubby’ antenna that is suitable for most applications, but where the signal is poor or the install is in a sensitive area, you should use hi gain antennas and/or low loss extension cables.

### SIM Card Slot

This is a standard SIM card slot (also known as mini SIM or 2FF).

### RS232 Serial Port

The serial port allows direct connection to a 9 way ‘D’ type connector on a PC via a pin to pin cable. See chapter 5 for details about this interface.

- Pin 1: N/C
- Pin 2: TxD
- Pin 3: RxD
- Pin 4: N/C
- Pin 5: Ground
- Pin 6: N/C
- Pin 7: CTS
- Pin 8: RTS
- Pin 9: N/C

### Ethernet Port

This is an RJ45 port which should be connected via CAT5 cable to an Ethernet device or switch. The port will automatically set the pins to suit (Auto-MDX) and select the maximum available speed (10Mbps or 100Mbps) depending on the connected infrastructure (Auto-Negotiation).



Figure 2-3: Rear Panel Controls

**Mains Input**

The power supply is connected via a filtered IEC Plug and is continuously rated 85-264V AC @ 47-63Hz.

**Protective Earth Terminal**

This earth bond screw terminal is a screen terminal that must be connected to an earth point.

**Configuration Settings DIPSwitches**

The SETTINGS switches are used to configure the DHY-04V in the modes that you want it to operate. A label on the top panel of the unit shows the orientation of the switches:

The following paragraphs describe the function of each switch; the default or normal position is shown in curly brackets.

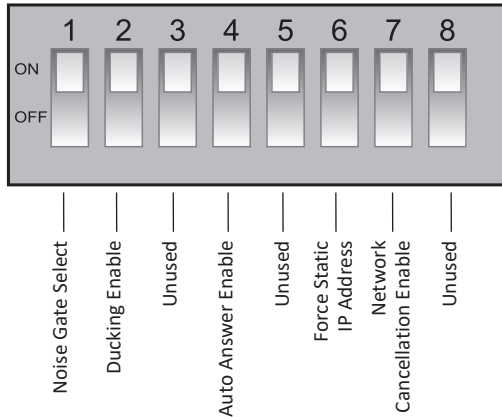

**Noise Gate Select - SW1 {ON}**

An output noise gate operates when the telephone signal is below the noise gate threshold control. This noise gate reduces the output gain by 34dB during low level signal conditions. The noise gate can be switched off if you don't wish to use it by switching SW1 to the OFF position.

**Ducking Enable - SW2 {ON}**

This switch allows the received signal to be automatically attenuated by 18db when both received and sent audio are present in the hybrid. This allows an operator in the studio to talk over the caller at all times.

**Ring Detector (Auto Answer) Enable - SW4 {ON}**

This switch enables the integrated ring detector, which automatically answers incoming calls after the number of rings set using the webserver (Configuration - Telephone). The default is 2 rings.

Note double cadence ring tones count both rings in the cadence pattern.

**Force Static IP Address – SW6 {OFF}**

When SW6 is enabled (ON) during the unit power-up routines, the Network settings are overridden to force the unit to use a static IP address of 192.168.0.100 with a subnet mask of 255.255.255.0

**Network Cancellation Enable – SW7 {OFF}**

When switch SW7 is enabled (ON) the DHY-04V performs the echo cancellation routine on the incoming signal from the telephone line. This is not normally required by a GSM network as the signal is already cancelled in the GSM network, but it may be enabled for special circumstances.

## 3 Connecting the DHY-04V

### IEC Mains

Connect the earth and mains power connections as per the information given in the Configuration & Controls sections of the handbook. The hybrid unit should be connected with reference to the following diagram.

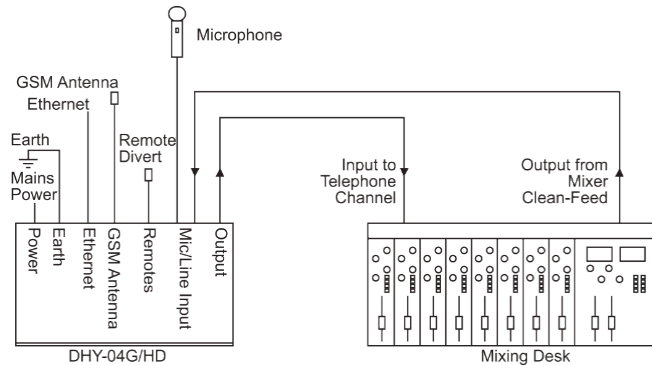

### GSM Antenna

Connect the GSM antenna to the rear panel and use the signal strength indicator to position the device/antenna to achieve the strongest signal.

### Remote Line Hold

A remote switch may be connected at the Remotes socket in order to control the line connect button from, say, the telco channel of a mixing desk.

Connect the output from the mixing desk “clean-feed” to the mic/line input of the DHY-04V, with the mic/line input select switch set to “Line”. A clean-feed is a signal produced by a telco module on a mixer which is used as the

output to be fed back to a caller on a telephone line. The cleanfeed is a sum of all the other signals which constitute the programme output, except for the caller’s audio (this is so that the caller doesn’t hear him/herself in the ear-piece). A cleanfeed signal will generally be of a better quality than a mix-minus signal.

### Mic/Line Input

The characteristics of the mic/line input are determined by the state of the mic/line configuration selection switch. It is a balanced bridging input and in line mode will accept normal signals at 0dBu peaking to +8dBu from a sound mixer clean feed. In mic mode the unit will accept 200 Ohm microphone level signals with a maximum gain of 71dB. It is suitable for a wide range of microphones and the available gain is 71dB to 29dB, which can be adjusted by the mic level pre-set mounted on the rear panel and the front panel ‘Level to Line’ Switch. The input circuitry to the DHY-04V has a very effective limiter, which will prevent high level overloading problems. Ideally, the maximum input level should not exceed +12dBu. This limiter is used for both line and mic input modes.

### XLR Output

Connect the output of the DHY-04V to the telco input of the mixing console. The output connection will deliver a balanced/floating low impedance signal of 0dBm from the telephone line. The output of the digital hybrid unit is normally 0dBu from a balanced source of 50Ω or less across the useful bandwidth of the equipment. The bandwidth is restricted by the signal quality of the GSM network connection. The output stage is capable of driving into 600 Ohm loads at up to +8dBu. Termination of the output is not necessary however and direct connection can be made into the mixer telephone return channel.

The output stage has a 3-way gain switch control, mounted on the front panel (Level to Line), which may be set to give 0dB signals at the output. In

addition an output noise gate operates when the telephone signal is below the noise gate threshold control. This noise gate reduces the output gain by 34dB under no signal conditions.

### Using The AES/EBU Input & Output

The unit is also capable of working in the digital domain by supplying AES/EBU digital audio into the input XLR. The unit will automatically detect this digital signal and so will change the output to a digital audio signal synchronised to this input. The unit will treat 0dBFS to be the equivalent to a +18dBu analogue signal. The AES lock LED will indicate when a valid AES signal is present. Signals above -6dBFS have AGC applied to limit the internal signal to a maximum of -6dBFS (equiv +12dBu).

**Note:** The earth bond at the screw terminal must be connected to a technical earth to ensure the safe operation of the equipment under all line conditions.

### Using The Webserver To Configure Options

At this point you should refer to Chapter 6 and connect to the DHY-04V using the webserver. Configure the IP address of the unit for your network operation and check the available option settings in the 'Configuration' webpage (see Fig 6-5, ).

## Using the DHY-04V

### Receiving a Call

Incoming calls can be answered manually from the line connect button, or the remote line connect switch, or automatically by enabling the auto answer feature (settings SW4 ON), or externally via the serial or Ethernet ports. Incoming calls simulate ringing by cadence illumination of the line connect button. The line connect button lamp is off in the non-connected mode and illuminated in the connected mode.

**Note:** The remote line hold output mimics the front panel line connect button lamp, i.e. it flashes when ringing and is on when the line is held.

The hybrid unit now behaves as a 4-wire to 2-wire converter with signal inputs at the mic/line input connector and telephone caller at the output connector.

The call may be cleared by re-pressing the line connect button, or by means of the remote divert switch, or via the serial or Ethernet ports. If the remote caller hangs up then the call is cleared automatically.

### Integrated Ringing Detector – Auto Answer

Ringing detectors can be used when you need to answer a call automatically, for instance: If a journalist files a report to a recorder over a telephone line, the call can be picked up after a set number of rings by the ringing detector. The DHY-04V has a built in ring detector that is enabled by setting SW4 on the rear panel.

### Making a Call

To initiate a call, use the speed dial/ redial buttons on the front panel, or use the serial port (directly or via SCi) or Ethernet port (directly or via the webserver) to request a call to a specific number. When the call has been established, the call will be handed over to the telephone hybrid unit. To clear the line at the end of the call, press the line connect button. The line connect button lamp is off in the non-connected mode and illuminated in the connected mode.

### Using Speed Dial Buttons

There are also 4 Speed Dial buttons on the front panel that can make calls to 7 numbers setup via the webserver. When dialling, the unit shows the dialling by a rotating illumination pattern on these buttons. Speed Dials 1-4 are accessed by a simple press on buttons 1-4, Speed Dials 5-7 and last number redial are accessed by pressing and holding buttons 1-4 respectively.

### Call Established

#### Level Setting

The DHY-04V hybrid operation is optimised for signals around 0dB. The front panel gain switches can adjust the signal levels for both caller and sender. The default position for these switches is receive gain (upper) fully counter-clockwise (-6dB) and the transmit gain (lower) to be in the middle (0dB). Set the lower switch so that the bargraph normally shows 0dB (second yellow LED) with occasional peak signal levels illuminating showing +6dB (first red LED). If your mixing desk or source audio is only sent at consumer level then J1 should be fitted on the PCB (See page 5 for details of this)

#### DTMF Detection

The caller can use this feature in conjunction with auto answer to force external actions from the DHY-04V. Once again in the case of a journalist ringing in a report, they can press a key on the telephone keypad to switch on an external recorder. The key used is set by the value in the webserver (Configuration - page 18). The presence of the DTMF tones in the incoming signal for the chosen key will activate the output on the remote connector.

#### Conference Calls

The DHY-04V has the ability to conference 2 calls on separate DHY-04V units together so that you need only to use 1 telco module on the mixer. These units are linked by a CAT5 cable (wired as shown below) via the RJ45 connectors on the rear of the units. The conference calls record feature is unavailable on the DHY-04V.

**Note:** This is not a standard CAT5, or CAT5 crossover, cable.

Establishing calls on both units will allow each caller to hear a mix of the clean-feed station output and the other caller. The feed to the mixer will contain a mix of both received calls.

The conference port cable simple cross-connects the Conference Input (Phase and Non-Phase) signals to the Conference Output (Phase and Non-Phase) signals respectively. It is available as an accessory, DHY-04CONF.

### Using the Conference Port as a Record Output

If you are not using the conference port, it can be used to provide a balanced audio output from the Conference Output Phase and Non-Phase pins. This output will contain just the caller signal unless the webserver option is selected (Configuration - page 18 ), which will create a mix of caller and sender on the record output.

### Using the Conference Port to Share a Stereo Digital Audio Connection between Two DHY-04V Units

The DHY-04V, when connected to a digital input, has the ability to receive a stereo signal. Normally just the left channel is used for the hybrid, but the unit can be set to use the conference port to feed the right channels to another hybrid, i.e. you can use a stereo signal to feed two hybrids automatically.

Set the first DHY-04V unit to Digital Master Conference mode in the webserver (Configuration - page 18 ) and use a crossover wired connection to another DHY-04V which is set to Digital Slave Conference mode (Configuration- page 18 ). Now the first unit provides a telco connection via the left channels and the slave unit provides a telco connection via the right channels.

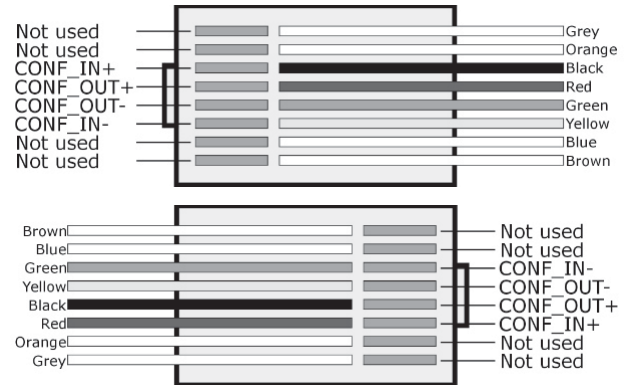

## 4 Hybrid Technical Description

A POTS hybrid (such as the DHY-04) has to be very flexible to maintain its operation for the many different countries' telephony systems, but with a GSM hybrid some of this functionality is provided by the Mobile Network. The network separates the send and receive traffic so there is no local echo to eliminate. However the quality of the network separation is not perfect, especially when the caller is using a POTS network to make the call. The DHY-04V provides the facilities to use noise gate and ducking functions to provide significant improvements in signal quality.

### Echo Cancellation

The echo part of the returned signal can be expressed in terms of delayed sent signal, and will not normally be required when using a GSM interface so we recommend setting DIPSwitch 7 to OFF. Occasionally the hybrid may be called on to perform echo cancellation, e.g. when echo is experienced from a remote call, and this is easily enabled by setting DIPSwitch 7 to the ON position.

The algorithm keeps a record of the set of recently sent data and, in the time domain, calculates the amount (hybrid coefficients) of signal being returned as echo back to the unit, subtracting this from the actual return signal to just leave the original caller signal. The echo cancellation filter has a variable length TAP with dynamic adaptation running on the on-board 24bit DSP. The length of this TAP is dependent of the expected delay in any echoes from the central exchange. The default length is 24ms, but the unit is capable of calculating delays up to 250ms.

The adaptation routines constantly adjust the internal hybrid coefficients to achieve the best echo cancellation. However the dynamic performance of this algorithm (i.e. the speed that the echo cancellation is optimised) is inversely dependant on the maximum delay (number of TAPs) allowed, so increasing the delay will result in a slightly poorer dynamic performance.

### Updating Firmware

The preferable method of communicating with the DHY-04V is to use the Webserver embedded within the DHY-04V Firmware.

The DHY-04V operating software is stored in flash memory and can be overwritten as new code is published. The flash memory is partitioned into boot code, firmware, and saved parameters. Only the firmware partitions are erased so that even in the unlikely occurrence of a power fail during the flash update, the system can still be recovered. If no firmware file is found, the unit will automatically start the Bootstrap code that contains a minimal webserver allowing the unit to have new code uploaded.

If a firmware file is corrupted, but still seen by the system as valid code then the unit will, most likely, not be able to connect to the integrated webserver. In this case you should force a bootstrap mode by powering up or resetting the unit whilst holding down the Line Hold button for approximately 8 seconds. The LEDs show an alternating 2on-2off pattern that switches to a 4on-4off pattern after 8 seconds. Now release the button and connect to the bootstrap webserver either by discovering the unit with the discovery app or by powering up with DIPSwitch 6 set to ON, when the unit will be found at a fixed static IP address of 192.168.0.100.

Select the firmware file to be uploaded – a link to our website is shown to fetch the latest version of code – and then press 'Update'. The DHY-04V will reboot when the file transfer is complete.

## 5 Serial Port Control

### DHY-04V Serial Connection

Default connection is 19200, e, 8, 1 and using XON/XOFF handshaking.

The serial port has reduced capability compared to the DHY-03 as the setup and firmware functions have been removed and are implemented by an embedded webserver.

### SCI Software

Sonifex provide free of charge software, SCI, to allow you to manage connection and control of the call handling aspects of the device. Go to [www.sonifex.co.uk/sci](http://www.sonifex.co.uk/sci) for the latest version.

### Serial Interface Commands & Responses

ANS:	- Answer Call	- ACK: or NAK:
BSV:	- BootStrap version	- BOOT:x.xx.xxx.xxx
CLR:	- Clear Call	- ACK: or NAK:
DTS:nnnn	- Send DTMF string nnnn	-ACK: or ERR:
MAC:	- MAC Request	- returns current MAC address
NET:	- Network Request	- returns active Network Parameters
SER:	-Serial Number Request	- SER:nnnnnnn
TEL:nnnnn	- Make Call	- ACK: or NAK: where nnnnn is tel number string or #n for speed dial numbers (1-7) or #L for redial last number
UID:	- Unit ID request	- UID:DHY-04V
VER:	- version request	- VER:x.xx.xxx.xxx
SRQ:	- Status Request	- See Below
STA:01	- Initialisation	
STA:02	- On Hook	
STA:03	- Ringing	
STA:04	- Off Hook - connected to line	
STA:05	- Dialling	
STA:06	- Firmware Update in progress	

### Error Messages

ERR:01	- Command Not Found
ERR:02	- Invalid Command (Error Unknown)
ERR:03	- Invalid Command (Invalid Parameters)
ERR:04	- Parameter out of range
ERR:05	- Write Parameter is Read Only
ERR:09	- Command not allowed when Call is Active
ERR:11	- Command not allowed when Call is Inactive

## 6 Webserver & Network Discovery

In addition to any physical controls the DHY-04V has a built in webserver which can allow you to control and configure the unit remotely through a web browser. The webpage interface also enables you to view status information, alter network settings, and update product firmware.

The Ethernet port should be connected to a network and then the unit will be accessible to all computers on that network - including smartphones/tablets if the network is WiFi compatible.

### Connecting to the Device

To connect to the device you will need to know either the unit's IP address or its Bonjour Name. To connect to the device by IP address (eg 192.168.0.100) connect via a browser by entering `http://192.168.0.100` in the address bar of the browser.

To connect via Bonjour Name in a Bonjour enabled device enter the name in the browser address bar. The default name is the device ID 'DHY-04V', a hyphen character '-', followed by the serial number without leading zeroes '1234' and then followed by '.local./' to indicate the local domain – so DHY-04V-1234.local./

The hostname can be changed to make it more memorable or descriptive of an implementation, however, conflicting names should be avoided.

### First Time Usage

The DHY-04V network interface employs Zeroconf networking, meaning that it supports DHCP, AutoIP and MDNS-SD using Bonjour. When you first get the unit it is set to use AutoIP and DHCP. If you have a DHCP on your server simply connect the device to your network and either run the discovery application or ask your network administrator for the assigned IP address. If you have a Bonjour enabled device enter the default name in the browser address bar as above. The nature of DHCP means that the unit is not guaranteed to maintain a fixed IP address each time it is reconnected to the network.

If your system network is unsuitable or doesn't have a DHCP server then the unit will use AutoIP which will poll addresses in the reserved range of 169.254.x.x until it finds an unused address. Unless your network uses this mechanism for IP address assignment, this will most likely be used when connecting a PC with a network cable directly between the unit and the PC. Ensure that the PC has dynamic addressing enabled in its network options and the AutoIP system will ensure that each device has a unique ID in the 169.254.x.x range. Now using the discovery app, find the IP address or if the PC is Bonjour enabled, type in the device name to the browser as above.

Finally if you are still having issues connecting – set DIPSwitch 6 to ON (up) and power cycle the unit. This will force the device to use a static IP address of 192.168.0.100

Once connection is established in a browser go to the Network tab and set the device to the settings appropriate for your network.

### MDNS-SD and Bonjour

Bonjour is an application created by Apple and is integral to Apple operating systems and the iTunes app. Bonjour for Windows is available as a plug-in for MS Internet Explorer®. Go to our website or other download stores and download the appropriate version for your operating system.

### Sonifex Service Discovery App

This is a free download for Windows from our website- [www.sonifex.co.uk/technical/software/index.shtml#sfxsrvdisc](http://www.sonifex.co.uk/technical/software/index.shtml#sfxsrvdisc)

It looks for classes of devices on the network and allows you to connect via a browser to them where appropriate. If Bonjour is installed select the Bonjour tab and then the Sonifex Web Server Service to show all devices. Select the device you wish to connect to, by type and serial number, and then launch to connect via a browser. If Bonjour is unavailable go to the Legacy Discovery tab, press the Refresh button, and if the device has a webserver you can select and launch the device.



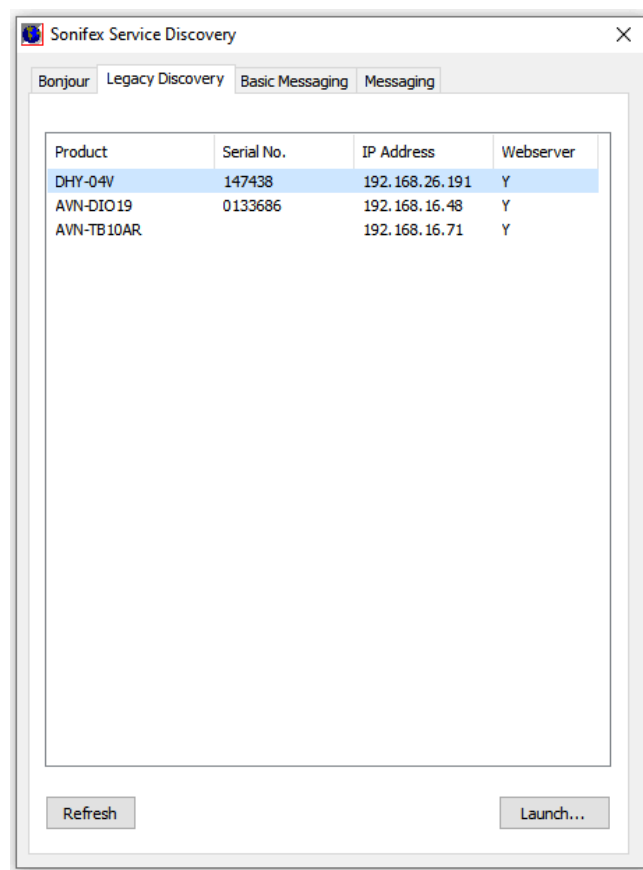
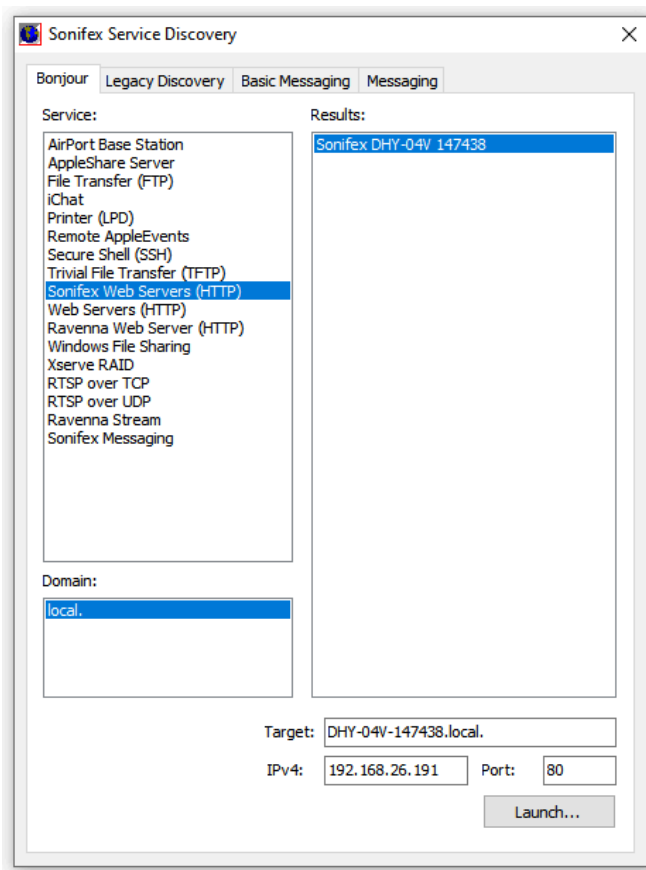

The screenshot shows the DHY-04 Web Server interface. At the top, there are logos for 'DHY 04 Telephone Hybrid', 'SONIFEX Manufacturers of audio & video equipment for radio & TV studios', and 'DHY-04V Web Server'. Below the logos is a navigation bar with links: Home | Config | Network | Device Info | Updates. The main content area is divided into three sections: Status, Line, and Dial. The Status section shows GSM Service: 3, Signal Strength: 69%, and Call State: On Hook. The Line section has buttons for Line Hold, Send DTMF (with input #\*123), and Save String. The Dial section has buttons for Dial Last, Call Back, and Dial Direct, followed by a table of Speed Dials with columns for Number and Name. The first row shows Speed Dial 1 with Number 01933650700 and Name Sonifex. There are also instructions and a warning message in the right-hand pane.

**Status**  
 GSM Service: 3  
 Signal Strength: 69%  
 Call State: **On Hook**

**Line**  
 Line Hold  
 Send DTMF #\*123 Save String

**Dial**  
 Dial Last  
 Call Back  
 Dial Direct

	Number	Name
Speed Dial 1	01933650700	Sonifex
Speed Dial 2		
Speed Dial 3		
Speed Dial 4		
Speed Dial 5		
Speed Dial 6		
Speed Dial 7		

Update Dial

**Home Page**  
 This page shows information about the line state and dialling possibilities of the connected DHY-04V.

**Status**  
 Shows the service provider, signal strength, and status of the GSM connection.

**Line**  
 Button to take control of the line in response to incoming ringing or to the drop currently connected call

The DTMF Send String is defined here and, when the line is connected, can be sent by the button or by the remote input. A serial command DTS:abcd will also send the DTMF string "abcd" directly

The 'Save String' button is used to send the string to the unit and save it in local memory. To erase the previously saved string, simply delete the input box content and click elsewhere (a warning message will appear).

To set a new DTMF string just type within the input box and then press the Save String button (or alternately press the enter key).

**Dial**  
 Controls to make outgoing calls to previously connected numbers, to a selection of 7 Speed Dials or to a directly entered number - type number in the box plus the return key to validate it.

To update the Speed Dials enter the number, and name if required, then press the update button to save the new information

The number entries should be preceded with the appropriate country codes to support international calling

Sonifex Ltd, 61 Station Road, Irthlingborough, Northants, NN9 5QE, UK. Tel: +44 (0)1933 650700 Fax: +44 (0)1933 650726 web: [www.sonifex.co.uk](http://www.sonifex.co.uk) email: [sales@sonifex.co.uk](mailto:sales@sonifex.co.uk)

## Home Page

The Home Page shows the status of the line, the line hold button and the various dialling options. Use this screen to change the 7 Speed Dial call numbers.

The Home Page is loaded on the first connection to the unit, chosen from the Home Menu dropdown and after uploading new firmware from the Update screen. Whilst calls are in progress you can also use this page to send DTMF audio data to the caller.

The Home Page can be protected by setting a password for Level 1 Access. If this is set and the appropriate password has not been entered, then the default becomes the Device Info Page.

## Status

Shows the status of the telephone line.

## Line

Control to take control of the line in response to incoming ringing or to drop currently connected call.

The DTMF Send String is defined here and, when the line is connected, can be sent by the button or by the remote input. A serial command DTS:abcd will also send the DTMF string "abcd" directly.

The 'Save String' button is used to send the string to the unit and save it in local memory. To erase the previously saved string, simply delete the input box content and click elsewhere (a warning message will appear).

To set a new DTMF string just type within the input box and then press the Save String button (or alternately press the enter key).

## Dial

Controls to make outgoing calls to previously connected numbers, to a selection of 7 Speed Dials or to a directly entered number - type number in the box plus the return key to validate it.

To update the Speed Dials enter the number, and name if required, then press the update button to save the new information

The number entries should be preceded with the appropriate country codes, using a '+' as the first character followed by the country code to indicate an international call.

### Dialler Page

The Dialler is selected from a drop down of the Home Menu and allows you to remotely dial out from a browser – including smartphones/tablets that are connected by WiFi via an access point to the DHY-04V.

This page shows the easy dialler screen and call state of the connected DHY-04V.

#### Call State

Shows the status of the GSM Connection.

#### Dial

Select Speed Dial (SD) numbers, or the last called number or manually enter a number and then press the Dial button to make a call.

Special characters are available via the shift key and the '<' key is used as a backspace.

The Dial button is also used to answer incoming calls or drop currently connected calls.

Once a call has been established, the web keypad can be used to send DTMF tones to the line.

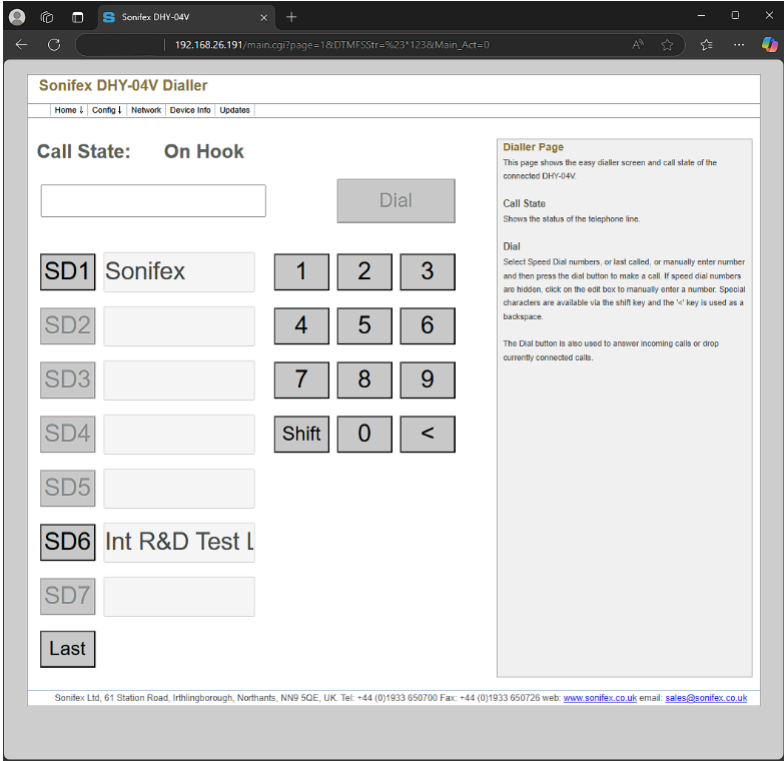

## Configuration

### Config Name

Enter the name used to identify the configuration set when saved in 'Updates'.

### Description

Enter the name used to identify the device in your studio e.g. Studio1 Telco Ch2.

### Echo Duration

Enter the time used in the echo cancellation algorithms. This defaults to 24ms which is more than sufficient for most telephone systems. However the unit is capable of handling line delays of up to 250ms.

**Note** that longer delays will affect the speed and accuracy of the echo cancellation algorithm.

### Local Number

Enter the number associated with the currently loaded GSM SIM.

### Conference Port Function

Select the function of the RJ45 conference port from the following :-

**Unused** - Conference Port has no function.

**Conference** - Conference Port allows 2 x DHY-04V units to share a single Mixer Telco channel.

**Record** - Conference Port outputs the caller for recording purposes.

**Record Mix** - Conference Port outputs a mix of the caller & the mixer send signal for recording purposes.

The screenshot displays the 'Configuration' page of the Sonifex DHY-04V web interface. The page is divided into several sections, each with a title and a list of settings:

- Configuration:**
  - Config Name: DHY-04V default setup
  - Description: Sonifex DHY-04V
  - Max Echo Duration: 24 (msec)
  - Local Number: [empty]
  - Conference Port Function: Unused
  - Force Analogue Output:
  - Hide Speed Dial Numbers:
- Answer Control:**
  - Auto Answer: Auto Answer 2 Rings
  - Buttons: Button , Remote , Ethernet
- Remote Ports:**
  - Input Port: Function: MomLatch Rem LineHold
  - Output Port: Function: Remote DTMF Follow Hash
  - DTMF Threshold: 108
  - DTMF Duration: 2
  - DTMF Detected String: None
  - Send DTMF to Serial Port:
- DTMF During the Call:**
  - Enable Auto Send of DTMF PIN:
  - DTMF PIN: None
- Auto Redial:**
  - Enable Auto Redial:

The right-hand side of the page shows a detailed 'Configuration' sidebar with explanatory text for each setting, such as: 'Enter the name used to identify the configuration set when saved in 'Updates'', 'Enter the time used in the echo cancellation algorithms. This defaults to 24ms but can range between 10 and a maximum of 250ms for the DHY-04G and 50ms for the DHY-04G-HD; however most occasions the GSM network will do the cancellation so the function should be disabled by setting DTP7 to the off position.', and 'Enter the number associated with the currently loaded GSM SIM.' At the bottom of the page, contact information for Sonifex is provided: 'Sonifex Ltd, 61 Station Road, Irthlingborough, Northants, NN9 5QE, UK. Tel: +44 (0)1933 650700 Fax: +44 (0)1933 650726 web: www.sonifex.co.uk email: sales@sonifex.co.uk'.

Figure 6-5: Telephone Configuration – selection of conference, auto answer, remote ports, DTMF during the call of Auto redial

**Digital Share Master** - Allows 2 x DHY-04V units to share a digital audio connection by connecting the right hand channel of the digital audio input and output data to the Conference Port.

**Digital Share Slave** - Retrieves the incoming audio and presents outgoing audio to the Conference Port.

### Force Analogue Output

The Main Output of the unit will follow the input type unless this option is selected when the output is always analogue.

Note it is not possible to output digital audio without a digital input being present.

### Answer Control

These options allow you to select automatic answering after a defined number of rings and to enable/disable various call control methods.

The auto-answer function is enabled by DIPSwitch 4.

### Submit Button

The Submit button saves the selection changes to the DHY-04V .

On the remote port there are 2 input and 2 output connections. In each case the first ports have predefined functions - effectively mirroring the front panel Line Hold control.

The second port functions can be defined here. Note that the factory supplied options are set to offer the same connectivity as hardwiring of the previous DHY-03 products.

### Remote Input Port

Select the functions of the GPI port between the following options :-

**Mom/Latch Rem Line Hold** - When this input is activated (i.e. connected to ground) the action of the Remote Line Hold input changes from Momentary to Latching mode.

**DTMF Start** - When this input is activated (i.e. connected to ground) and a GSM call is active, then the currently set DTMF String in the Home Page is sent to the line. When this option is selected then the action of the Remote Line Hold is determined by the checkbox below. Note that if you choose to send DTMF from the unit then during that period the DTMF detect circuits are inhibited.

### Remote Output Port

Select the functions of the GPO port either as a specific info about ring or call connection or to output the state of the DTMF detection circuit.

**Remote Off** - remote GPO has no function.

**Remote Ring** - remote GPO reflects Ring detection.

**Remote Connected** - remote GPO is active when the unit is connected.

**Remote DTMF Detect String** - remote GPO is active once the DTMF String below has been detected from the caller

**Remote DTMF Toggle String** - remote GPO is toggled every time the DTMF String below has been detected from the caller.

**Remote DTMF Follow Hash** - remote GPO is active while the DTMF Hash character is detected from the caller.

**Remote DTMF Hash Toggle** - remote GPO is toggled every time the DTMF Hash character is detected from the caller.

Some networks, especially PABXs, can have short, low level DTMF signalling. The DTMF parameters for Threshold and duration can be set here to account for this. The Threshold defaults to 108 which is approx. equivalent to -12dB and can be decreased/increased for lower/higher level signals. The Duration is the number of tests to be performed, with each test taking slightly over 25ms, so the default of 2 represents a duration of around 51msec. A longer duration will allow for a more consistent result, but requires that the DTMF signal is present for longer. Conversely, a shorter number of tests could have the propensity to generate false positives when audio is present.

If you select DTMF Detect/Toggle then set a the DTMF Detect String to a character or string for detection.

Finally the serial port can be made to reflect any DTMF signals directly as they are selected via a DTD:x (DTMF Tone Detect) where x is the DTMF signal detected.

## DTMF during the call

The following options will allow you to send a DTMF / Touch Tone PIN automatically on connection of a call.

**Enable Auto Send of DTMF PIN** - Tick this box to automatically send DTMF tones on connection of a call (after dialling or answering).

**DTMF PIN** - Enter up to 4 digit PIN number into this box (to be sent on connection of a call).

## Auto Redial

The following options will allow the unit to automatically recall either the last called/taken number or a specific number (if it has been set) if the call is dropped at the far end.

**Enable Auto Redial** - Tick this box to enable the auto redial capability. Once enabled the unit will automatically recall either the last dialled/hooked number or the following inserted number.

**Auto Redial Number** - Enter the number that needs to be automatically recall if dropped at the far end. Note if this input box is empty when submitted, the unit will automatically recall either the last dialled or the last hooked number.

To erase the previously saved number, simply delete the Auto Redial Number input box content and click elsewhere, a warning message will appear (as shown in Figure 6-6) then press <<OK>> on the pop-up windows and then <<Submit>> to save the changes.

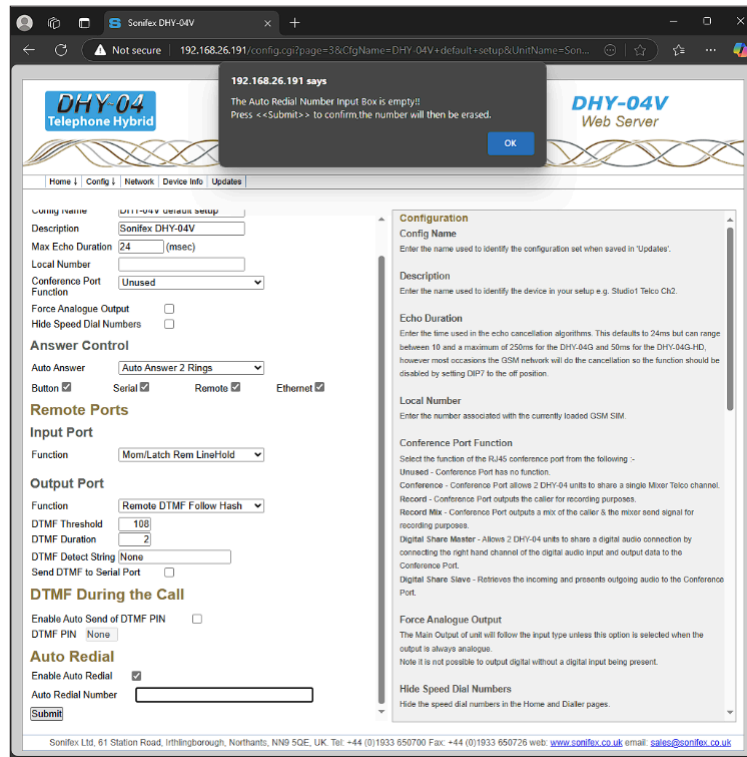

Figure 6-6: Auto redial warning message



Figure 6-7: Password Setting Page

## Password Setting

The Password Setting Page allows you to restrict access to certain pages on the Webserver. Setting Level 1 password protects access to the Home and Dialler Pages, and if the level 2 password is not set it will also restrict access to those pages protected by the level 2 password. Set the level 2 password to restrict access to all the settings pages – i.e. Configuration, Password Setting, Network and Updates. The password requires 5 digits of case-sensitive alphanumeric characters or should be cleared to remove the password protection.

The Automatic Log Out Time is between 0 and 30, where 0 is disabled and 1-30 is the inactivity timeout period in minutes for the Hybrid to automatically log out.

The DHY-04V can store a SIM card Access Code (or PIN) if you wish to protect the SIM card from being misused on other equipment. If you load a protected SIM card then the SIM Enabled LED will flash to indicate a problem with the SIM and a message will be shown on the Device Info page. If a SIM requires an access code then the message displayed will be +CPIN: SIM PIN

Enter the Access Code here and press the submit button and the PIN will be applied to the SIM card and, assuming it is correct, network access will be available now and automatically every time the unit is powered up.

**Please note** that other passwords or secondary access codes are not settable here.



Figure 6-8: Network Page – settings for network interface

## Network Settings

The Network Page allows you to change the method of IP assignment for the unit and to alter the Hostname used by Bonjour for automatic connection regardless of the IP address assigned.

Note: Submitting new network settings can cause the browser to lose connection. the DHY-04V will attempt to re-connect to the device and most browsers will eventually do this. The process is speeded up by refreshing the page after 15 seconds, but some (notably Internet Explorer) will not respond to this refresh and will require a shut-down and restart, or you should wait a few minutes then refresh the connection.

### Bonjour Name

Enter the host name used by Bonjour. The Host name can be up to 63 alphanumeric characters in length, and can include hyphens (-). The default name is the Device ID then '-' then serial number without leading zeroes.

If a conflict occurs on the network this value will be modified to ensure a unique name.

### Static IP Address

Enter the static IP address that you wish to assign to this unit. This IP address will be used if Dynamic addressing is disabled. The default static IP address - and the IP address when DIPSwitch 6 is active during power on - is 192.168.0.100



### Static Subnet Mask

Enter the subnet mask of the network you wish to connect to.

The default subnet mask is 255.255.255.0

### Gateway IP Address

Enter the gateway IP address of your router.

The default gateway is 192.168.0.1

### Dynamic Addressing

Enable dynamic addressing (DHCP or AutoIP) to allow the unit to acquire its IP address automatically from a DHCP server and/or using AutoIP. Disable both options to use the static IP address entered on this page.

To transfer the new network settings to the connected DHY-04V, press the Submit button.

This may require a restart by Internet Explorer and, if the device is being accessed by a direct IP address, you will probably have to enter the new IP address in the address bar.

The screenshot shows a web browser window displaying the Sonifex DHY-04V Web Server configuration page. The page has a header with the Sonifex logo and 'DHY-04V Web Server' text. Below the header is a navigation menu with 'Home', 'Config', 'Network', 'Device Info', and 'Updates'. The main content area is divided into three sections: 'Device Info', 'Network Info', and 'GSM Info'. The 'Device Info' section lists various parameters such as Device, Serial Number, Description, Bonjour Name, Firmware Version, Base Version, Front Panel Version, GSM Module Version, GSM Device Version, Config Set, and System Up Time. The 'Network Info' section lists Connectivity, Actual IP Address, Actual Subnet Mask, Actual Gateway IP, and Hardware Address. The 'GSM Info' section lists Call State, Operator, Signal Strength, Telephone Number, Model ID, IMEI Number, and SIM Access Msg. A footer at the bottom of the page provides contact information for Sonifex Ltd.

**Device Info**

Device:	DHY-04V
Serial Number:	147438
Description:	Sonifex DHY-04V
Bonjour Name:	DHY-04V-147438
Firmware Version:	v1.21.160.169
Base Version:	v1.01.091
Front Panel Version:	v1.00
GSM Module Version:	v1.14
GSM Device Version:	v
Config Set:	DHY-04V default setup
System Up Time:	0h 45m 15s

**Network Info**

Connectivity:	DHCP - 100Mbps
Actual IP Address:	192.168.26.191
Actual Subnet Mask:	255.255.255.0
Actual Gateway IP:	192.168.26.1
Hardware Address:	DD:A4:B1:00:46:82

**GSM Info**

Call State:	On Hook
Operator:	LycaMobile
Signal Strength:	81%
Telephone Number:	
Model ID:	LE910C1-WVX
IMEI Number:	350936963859500
SIM Access Msg:	+CPIN: READY

**Device Info**

This page shows general, network and GSM information about the connected DHY-04V.

Sonifex Ltd, 61 Station Road, Irthlingborough, Northants, NN9 5QE, UK. Tel: +44 (0)1933 650700 Fax: +44 (0)1933 650726 web: [www.sonifex.co.uk](http://www.sonifex.co.uk) email: [sales@sonifex.co.uk](mailto:sales@sonifex.co.uk)

Figure 6-9: Device Info Page – shows info about the DHY-04V product

## Device Info Page

The Device Info page is self-explanatory as it shows info about the device.



Figure 6-10: Updates Page – to update the system firmware and load/save configuration files

### Update Firmware Page

The Update page allows you to load new versions of firmware which may be published on the Sonifex Website from time to time. The firmware update may contain small changes like bug fixes etc, or may contain major new features. To find out if there is new firmware for this unit, check the Sonifex website.

Generally major features would be indicated by a step in the first firmware version number, whereas small fixes would be only shown in the 'decimal places' or even the build revision.

The device configuration can be saved or loaded from the local PC running the browser. All information about the configuration is saved, but, to allow replication across multiple machines there a few parameters (e.g. IP Address and host name) that are specific to the unit and will not be loaded.

### Update Firmware

If an update is available, download the latest version and save the file to your computer. Browse your computer to locate, select the file, and press the Update button. Once the update has started, this page will refresh automatically.

The file must be named according to the following convention "DHY04G\_HD\_" followed by any version or other info then a ".dwn" suffix - e.g "DHY04G\_HD\_v2\_07 special release.dwn".

### **Update GSM Module**

The GSM Module runs firmware to control the calls and report the status to the main DHY-04V firmware. If an update is available, download the latest version and save the file to your computer. Browse your computer to locate and select the file, and press the update button. Once the update has completed, this page will refresh automatically.

The file must be named according to the following convention "DHY04G\_HD\_MOD\_" followed by any version or other info then a ".hex" suffix - e.g "DHY04G\_HD\_MOD\_v1.2.hex"

### **Update Config Files**

The settings created in the Configuration page can be retrieved from or saved to your computer.

To Load a Config Set, select a file and press Load Config and the options from the config file will be loaded onto the DHY-04V unit.

Just press Save Config to create a file named DHY04G\_HD.ini in the download directory of the browser. The configuration file is always saved to the download directory as DHY04G\_HD.ini, but can be edited, renamed or moved to a more convenient location directly on your computer. The file is man-readable and editable. For special setups we sometimes provide a config file to create a special User set to suit customers specific conditions.

### **Clear Settings**

Press this button to clear the settings in the main code. Take care as all settings will be lost - if necessary use the config save to keep a record of settings



## Log In

Enter the 5 digit case-sensitive alphanumeric password to allow access to protected pages. This password should match either the level 1 or level 2 passwords setup in the Password Setting Page.

Once a correct password has been entered access to the appropriate screens will be enabled, until the user selects the Log Out menu or the unit is inactive for the Automatic Log Out Time set in the Password Setting Page.

**UPDATE FIRMWARE**

Please visit our [software downloads](#) page for firmware updates.

Choose File | DHY04G\_HD\_v1\_21.dwn

Update

**CLEAR SETTINGS**

Factory Reset

**DEVICE INFO**

Serial Number: 147438  
 HostName: DHY-04V-147438  
 Firmware Version: v1.01.091.169

**NETWORK INFO**

Connectivity: DHCP - 100Mbps  
 Actual IP Address: 192.168.26.191  
 Actual Subnet Mask: 255.255.255.0  
 Actual Gateway IP: 192.168.26.1  
 Hardware Address: D0.A4.B1.00.46.82

**Update**

The version of firmware currently running on this unit is v1.01.091.169.

To find out if there is new firmware for this unit, check the Sonifex website. If an update is available, download the latest version and save the file to your computer. Browse your computer to locate and select the file, and press the update button. Once the update has started, this page will refresh automatically.

The file must be named according to the convention "DHY04G\_HD" followed by any version or other info then a ".DWN" suffix - e.g "DHY04G\_HD v2\_07 special release.dwn"

**Clear Settings**

Press this button to clear the settings in the main code. Take care as all settings will be lost - if necessary use the config save from the main code to keep a record of settings

**Device Info**

These sections shows general & network information about the connected DHY-04HD.

Sonifex Ltd, 61 Station Road, Irthlingborough, Northants, NN9 5QE, UK. Tel: +44 (0)1933 650700 Fax: +44 (0)1933 650726 web: [www.sonifex.co.uk](http://www.sonifex.co.uk) email: [sales@sonifex.co.uk](mailto:sales@sonifex.co.uk)

## Bootstrap Mode

This mode is entered when the unit cannot find a valid version of firmware in the flash memory. Alternatively the bootstrap mode can be forced by holding down the Line Hold button for an extended duration of approximately 8 seconds whilst powering-up the unit. The meter LEDs will flash as alternate pairs until the duration has been achieved, when it will show a set of 4 on/off pattern.

In bootstrap mode the unit can only be used to load new firmware from the web interface or to clear all settings back to the factory defaults. The unit will default to DHCP and AutoIP enabled, in which case use the Sonifex Service Discovery App or check with the administrator of the DHCP server to discover the device IP address.

If DIPSwitch 6 is ON (up) during power up, then the unit will ignore the dynamic addressing options and will use a static IP address of 192.168.0.100

Connect to the device on our browser by typing 'http://' followed by the IP address in the browser address bar – eg 'http://192.168.0.100'. Now you can either press the 'Factory Reset' button to clear the settings to factory defaults or upload a file. To do this choose File button and select the correct download file. Now press the Update button and the unit will accept the new firmware and re-program the flash memory with the new code. The webpage will display an 'Ok' message that will automatically update to the new home page once the program and reset functions are completed. The new firmware will use any previously saved settings.

## 7 Technical Specification DHY-04V

### Audio Specification Analogue Audio I/O

Input Impedance - Line Mode (Clean Feed):	10kΩ balanced 0dB
Input Impedance - Conferencing:	10kΩ balanced 0dB
Input Impedance - Microphone Mode:	2kΩ balanced
Input Level Gain Range:	-6dB, 0dB, and +6dB adjusted by 3-position front panel switch, +10dB jumper
Microphone Level Gain Preset:	From 65dB to 35dB
Maximum Input Levels:	Line +26dBu, mic -24dBu
Clean Feed Limiting Input:	-4dBu for CTR21 setting, other values available
Output Impedance - Line Out:	50Ω balanced floating 0dBu
Output Impedance - Conference/Record:	50Ω balanced floating 0dBu
Output Level Gain Range:	-6db, 0dB, and +6dB adjusted by 3-position front panel switch

### Digital Audio I/O

Input Impedance:	110Ω ±20% balanced
Output Impedance:	110Ω ±20% balanced
Sample Frequency Range:	30 - 100kHz (i.e. including 32kHz, 44.1kHz, 48kHz, 64kHz, 88.2kHz & 96kHz)
Signal Level:	2V/7V peak to peak min/max
Analogue equivalent Level for Full Scale Digits:	+18dBu
Maximum Input Level:	0dBFS but internally limited to -6dBFS
Maximum Output Level:	-6dBFS

### DHY-04V Cellular Connection

Module Type:	LTE Cat.1 4G with 3G/2G fallback & VoLTE/3G/2G for EMEA/North America/APAC/LATAM 3GPP
Approvals Information:	FCC/ISED, PTCRB (North America) RED/GCF (Europe)

## 7 Technical Specification

Ring Detector Sensitivity: Off, 1, 2, 3, or 4 rings

### Power Supply

Power to DHY-04V, S & T  
Universal 12W power supply: 90 to 250V AC; 47-63Hz; fused 1A anti-surge fuse

### Connections

Mic/Line/AES-EBU Input: XLR 3 pin female, with push-button mic/line selection  
Line/AES-EBU Output: XLR 3 pin male  
GSM Antenna: SMA socket  
Conferencing or Record Audio: RJ45 socket  
Remotes: 9-way D-type socket  
Ethernet: RJ45 socket  
RS232 Serial: 9-way D-type socket  
Power: IEC mains (CEE22)

### Accessories Order Code

### Description

DHY-04VCON Front panel conversion kit, DHY-04VS to DHY-04V  
DHY-04VSCON Front panel conversion kit, DHY-04V free standing to DHY-04VS 19" (48cm) rack-mount front  
DHY-04VTCON Front panel conversion kit, DHY-04V or DHY-04VS, to DHY-04VT 19" (48cm) rack-mount front



Physical Specification Order Code	Description	Height	Width	Depth*	Total Nett Weight	Total Gross Weight
DHY-04V (Raw):	Automatic digital GSM hybrid	4.5cm 1.8"	21.8cm 8.6"	17.5cm 6.9"	1.4kg 3lbs	2.2kg 4.8lbs
DHY-04V (Boxed):		6cm 2.4"	34cm 13.4"	27cm 10.6"		
DHY-04VS (Raw):	Automatic digital GSM hybrid	4.5cm (1U) 1.8" (1U)	48.3cm (19" rack width)	17.5cm 6.9"	1.45kg 3.2lbs	2.3kg 5lbs
DHY-04VS (Boxed):		6.8cm 2.7"	58.8cm 23"	27cm 10.6"		
DHY-04VT (Raw):	Twin automatic digital	4.5cm (1U) 1.8" (1U)	48.3cm (19" rack width)	17.5cm 6.9"	2.80kg 6.2lbs	4.4kg 9.7lbs
DHY-04VT (Boxed)		6.8cm 2.7"	58.8cm 23"	27cm 10.6"		

\*Depth is measured from the front to the end of the connectors fitted to the back of the unit.

[www.sonifex.co.uk](http://www.sonifex.co.uk)

t:+44 (0)1933 650 700  
sales@sonifex.co.uk